

HydroControl V

Double regulating valves PN 25 / PN 16
DN 15...50



Double regulating valve for static hydronic balancing of pipe networks in closed heating and cooling systems. It offers a measuring function over the valve seat.

The HydroControl V consists of a flow optimised Y-pattern body, a valve insert with low pitch, double O-ring sealing, ergonomically designed handwheel and sophisticated cone shaped plug as well as two HydroPort auxiliary valves. All functions are accessible from the top.

Functions

- Flow regulation with reproducible, blockable and lead-sealable presetting
- Shutoff
- Connection for flow measurement
- Connection for impulse tube
- Draining, filling and venting the system section upstream or downstream of the valve

Features

- + High flow range for easy sizing
- + All functions always included for easy selection
- + New HydroPort auxiliary valves for easy, quick and safe connection of accessories

Product Details

Technical Data

Nominal sizes	DN 15...50
Variants	With internal thread according to EN 10226 With external thread according to ISO 228
Operating temperature	-20...150 °C
Operating pressure	Internal thread: max. 25 bar / PN 25 External thread: max. 16 bar / PN 16
Medium	Heating and cooling water according to VDI 2035 or ÖNORM 5195 Water-glycol mixtures with max. 50% glycol content
Kvs values	3.9...42.9

Construction

	Component	Material
	Multi-part handwheel set with presetting from the top	Polyamide plastic
	Flow optimised Y-pattern body	Dezincification resistant brass
	Bonnet, spindle and regulating plug	Dezincification resistant brass with EPDM O-rings
	Seat seal	PTFE
	HydroPort valves	Dezincification resistant brass
	HydroPort seals	EPDM O-ring
	HydroPort protection caps	TPE

Functions

Flow regulation

The flow is regulated by limiting the stroke of the valve plug and thus reducing the opening between the valve plug and the valve seat. The low thread pitch allows very precise setting. The plug position is shown on the top side of the handwheel on a scale from 0.0 (closed) to 4.85 (fully open) in increments of 0.05. This value is the presetting.

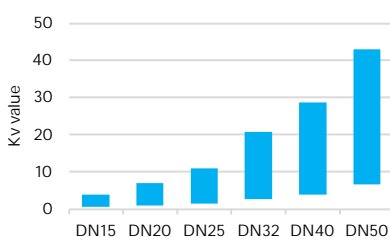

The HydroControl V has a linear characteristic line and a wide flow range evenly graded over all nominal sizes.

As is usual with regulating valves, small presettings reduce the flow accuracy. Therefore, a presetting below 0.5 should be avoided with the HydroControl V.

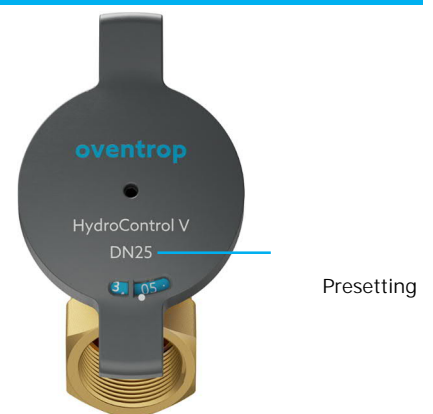

Presetting

- Reproducible: when the valve is closed, it can only be opened to the set presetting value
- Blockable: the valve is blocked at the presetting position
- Lead-sealable: the valve can additionally be lead sealed, e.g. with sealing wire (item no. 1089091)

Shutoff

Turning the handwheel clockwise until it stops shuts off the pipeline tightly.

HydroPort

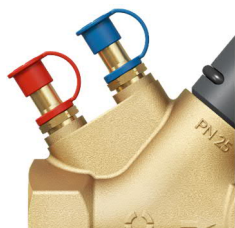

Each HydroControl V is equipped with two HydroPort auxiliary valves. The HydroPort valves allow easy and secure snap-on connection of accessories. HydroPort valves are opened by a short turn with a 13 mm open-end spanner. A quarter turn is sufficient to measure the pressure, three quarters of a turn is sufficient to drain and fill.

FILLING, DRAINING AND VENTING

Filling, draining and venting is done with the HydroPort adapter (item no. 1069601). When the main valve is in the shutoff position, the system section upstream or downstream of the valve can be selectively filled or drained.

IMPULSE TUBE CONNECTION

The HydroPort valve enables a quick, safe and secure connection of the impulse tube of a HydroControl D differential pressure regulator. Impulse tubes of other differential pressure regulators can be connected with the HydroPort adapter and suitable connection pieces.

CONNECTION OF AN OV-DMC 3

The measuring hoses of an OV-DMC 3 measuring device can be connected directly to the HydroPort.

Measurement

A commercially available differential pressure gauge can be connected via the standard HydroPort auxiliary valves, for example the Oventrop OV-DMC 3. Based on the measured differential pressure and the Kv value, the flow rate can be calculated. This calculation is also carried out by the OV-DMC 3, so that the flow value is displayed directly during measurement. If two temperature sensors are used, the power is calculated and displayed in addition to the flow rate.

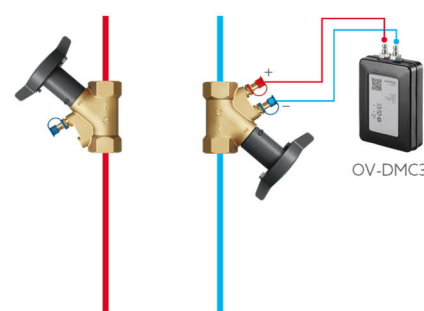

AUTOMATIC VALVE IDENTIFICATION

The Kv value depends on the manufacturer, model, nominal size and stroke position (=presetting value). Kv values for all Oventrop control valves and for all other common control valves are stored in the OV-DMC 3. To facilitate and speed up the determination of the correct Kv value, the OV-DMC 3 can automatically identify the model, nominal size and presetting using a smartphone camera. However, this function is limited to Oventrop double regulating valves.

Application

- For static balancing of main and distribution pipes in central heating and cooling systems. In such applications, the HydroControl V is traditionally installed in the return pipe. Installation in the supply pipe is also possible without restrictions. A HydroControl A shutoff valve is sufficient as partner valve.
- As partner valve for a differential pressure regulator. For this application, the HydroControl usually has to be installed in the supply pipe, as most differential pressure regulators must be installed in the return pipe. When using a HydroControl V as partner valve for a HydroControl D differential pressure regulator, the actual flow can be measured with the OV-DMC 3 and limited if necessary.

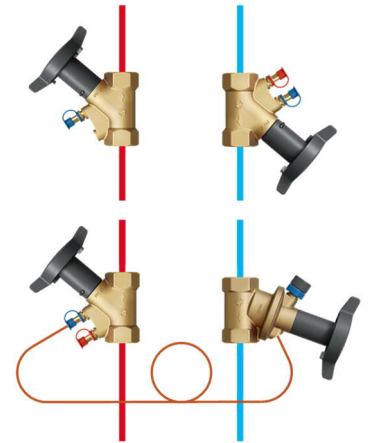

Installation

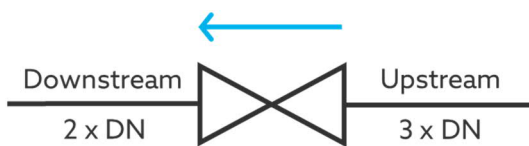

Calming sections of 3 x DN upstream and 2 x DN downstream of the HydroControl V should be provided.

The valve must be installed correctly in the flow direction which is indicated by an arrow on the body.

Dimensions

DN	INTERNAL THREAD			EXTERNAL THREAD			B [mm]	H [mm]	Weight [kg]
	Conne- tion	L1 [mm]	L2 [mm]	Conne- tion	L1 [mm]	L2 [mm]			
15	Rp 1/2	72	142	G 3/4	88	149	109	129	0.57
20	Rp 3/4	84	152	G 1	93	154	109	136	0.67
25	Rp 1	98	160	G 1 1/4	109	164	109	147	0.99
32	Rp 1 1/4	116	172	G 1 1/2	134	182	109	157	1.44
40	Rp 1 1/2	124	177	G 1 3/4	144	187	109	164	1.80
50	Rp 2	155	195	G 2 3/8	166	204	109	184	3.10

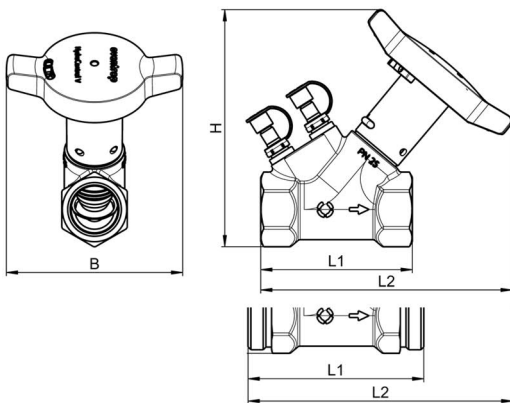

Item Numbers

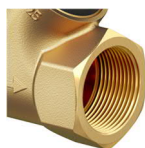

INTERNAL THREAD

EXTERNAL THREAD

DN	Kvs value	Connection size	Item no.	Connection size	Item no.
15	3.9	Rp ½	1062404	G ¾	1062604
20	6.9	Rp ¾	1062406	G 1	1062606
25	11.0	Rp 1	1062408	G 1 ¼	1062608
32	20.8	Rp 1 ¼	1062410	G 1 ½	1062610
40	28.7	Rp 1 ½	1062412	G 1 ¾	1062612
50	42.9	Rp 2	1062416	G 2 ¾	1062616

Accessories

HydroPort adapter



With external thread G ¾.
For connecting accessories to HydroPort auxiliary valves. Also suitable for permanent connection, e.g. for impulse tubes of third-party controllers. This adapter is not required for connecting the impulse tube of the HydroControl D.

Suitable for	Item no.
All nominal sizes	1069601

HydroPort extensions (2-fold)

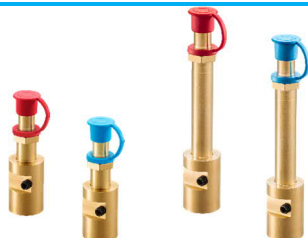

For extending HydroPort auxiliary valves on insulated valves. For permanent attachment to the valve. 2 each with red and blue marking.

Length	Suitable for	Item no.
L=40 mm	All nominal sizes	1069602
L=80 mm	All nominal sizes	1069603

Wire seal kit



10-fold, consisting of seal and sealing wire

Suitable for	Item no.
All nominal sizes	1089091

Insulation shells



Only for heating systems. Meets the requirements of Appendix 8 to section 69 and 71 (1), line ee) of the German Building Energy Act (GEG). Building material class B2 according to DIN 4102 / E according to EN 13501-1. Operating temperature up to 110 °C.

Suitable for	Item no.
DN 15	1069610
DN 20	1069611
DN 25	1069612
DN 32	1069613
DN 40	1069614
DN 50	1069615

Fittings



Connection set with externally threaded tailpipes.
Consisting of two tailpipes, union nuts and sealing rings.
Suitable for HydroControl V with external threads.

Size	Suitable for	Item no.
R ½	DN 15	1140792
R ¾	DN 20	1140793
R 1	DN 25	1140794
R 1 ¼	DN 32	1140795
R 1 ½	DN 40	1140796
R 2	DN 50	1140797

Replacement insert



Suitable for	Item no.
DN 15	1069020
DN 20	1069021
DN 25	1069022
DN 32	1069023
DN 40	1069024
DN 50	1069025

Sizing

This Product Data sheet offers various options to size the HydroControl V:

- Use the alignment chart below for a quick sizing across all nominal sizes
- Use the Kv value table and the flow charts on the following pages for an accurate determination of the presetting value
- At the end of the Product Data sheet, you will find information on the exact Kv value calculation taking into account the medium temperature. Furthermore, you will find information on the approximate calculation of corrected flow values when using glycol mixtures as well as a link to the digital data slider HydroSet.

Alignment Chart

The alignment chart allows to graphically determine the Kv value. To do this, draw a line and lay it out so that it crosses the desired flow rate (1) on the left-hand scale and the available differential pressure (2) on the right-hand scale - in the example below, the blue line that crosses the respective scales at 0.6 m³/h and 10 kPa. Now the Kv value (3) can be read off the middle scale, in this case 1.9.

By drawing a line from the Kv value scale to the right (in the example below, the grey line), you will find the nominal sizes that come into question for the required flow rate. For a Kv value of 1.9, DN 15 to DN 25 are basically suitable. However, control and regulating valves are often operated at the upper end of their capacity. Therefore, DN 15 or DN 20 should preferably be used in this case.

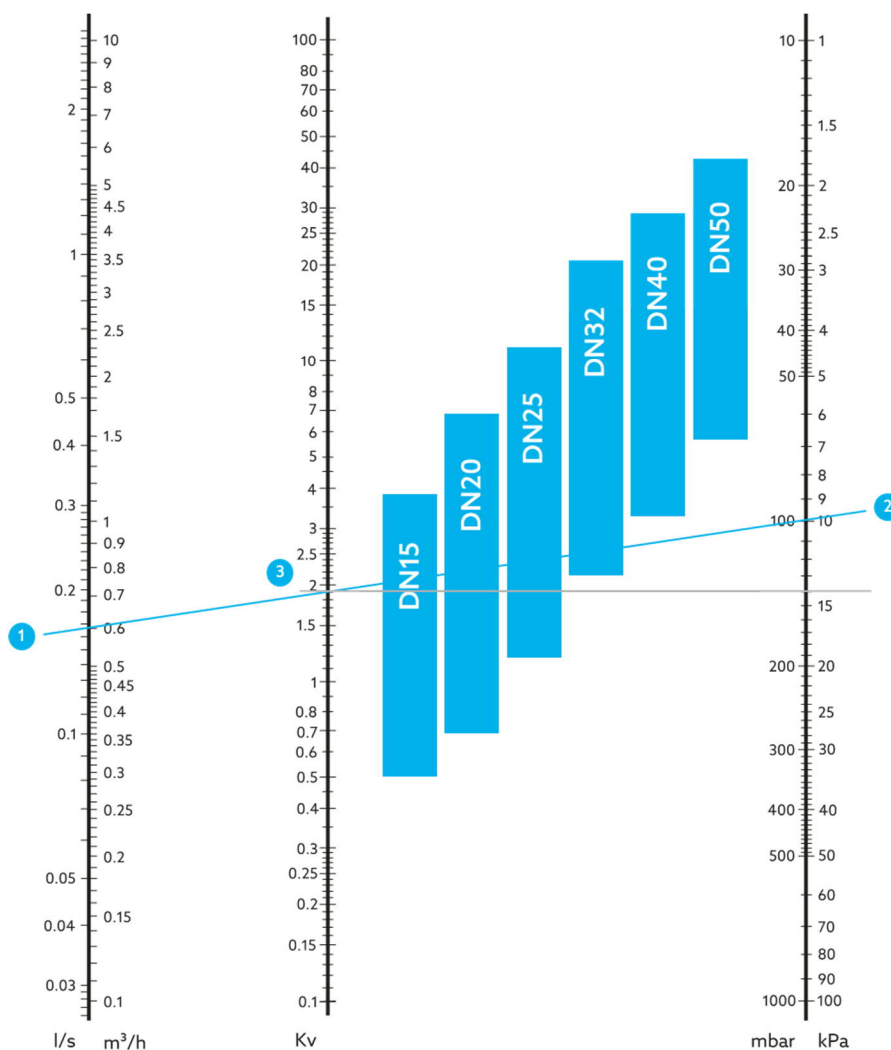

Kv Values

V	DN 15	DN 20	DN 25	DN 32	DN 40	DN50
0.0	0	0	0	0	0	0
0.1	0.10	0.14	0.24	0.43	0.65	1.09
0.2	0.20	0.28	0.48	0.86	1.30	2.18
0.3	0.30	0.42	0.72	1.29	1.95	3.27
0.4	0.40	0.56	0.96	1.72	2.60	4.36
0.5	0.50	0.70	1.20	2.15	3.25	5.45
0.6	0.60	0.84	1.44	2.58	3.90	6.54
0.7	0.70	0.98	1.68	3.01	4.55	7.63
0.8	0.80	1.12	1.92	3.44	5.20	8.72
0.9	0.90	1.26	2.16	3.87	5.85	9.81
1.0	1.0	1.4	2.4	4.3	6.5	10.9
1.1	1.06	1.53	2.61	4.67	6.98	11.69
1.2	1.12	1.66	2.82	5.04	7.46	12.48
1.3	1.18	1.79	3.03	5.41	7.94	13.27
1.4	1.24	1.92	3.24	5.78	8.42	14.06
1.5	1.30	2.05	3.45	6.15	8.90	14.85
1.6	1.36	2.18	3.66	6.52	9.38	15.64
1.7	1.42	2.31	3.87	6.89	9.86	16.43
1.8	1.48	2.44	4.08	7.26	10.34	17.22
1.9	1.54	2.57	4.29	7.63	10.82	18.01
2.0	1.6	2.7	4.5	8.0	11.3	18.8
2.1	1.69	2.83	4.70	8.37	11.81	19.53
2.2	1.78	2.96	4.90	8.74	12.32	20.26
2.3	1.87	3.09	5.10	9.11	12.83	20.99
2.4	1.96	3.22	5.30	9.48	13.34	21.72
2.5	2.05	3.35	5.50	9.85	13.85	22.45
2.6	2.14	3.48	5.70	10.22	14.36	23.18
2.7	2.23	3.61	5.90	10.59	14.87	23.91
2.8	2.32	3.74	6.10	10.96	15.38	24.64
2.9	2.41	3.87	6.30	11.33	15.89	25.37
3.0	2.5	4.0	6.5	11.7	16.4	26.1
3.1	2.58	4.15	6.70	12.15	17.00	26.91
3.2	2.66	4.30	6.90	12.60	17.60	27.72
3.3	2.74	4.45	7.10	13.05	18.20	28.53
3.4	2.82	4.60	7.30	13.50	18.80	29.34
3.5	2.90	4.75	7.50	13.95	19.40	30.15
3.6	2.98	4.90	7.70	14.40	20.00	30.96
3.7	3.06	5.05	7.90	14.85	20.60	31.77
3.8	3.14	5.20	8.10	15.30	21.20	32.58
3.9	3.22	5.35	8.30	15.75	21.80	33.39
4.0	3.3	5.5	8.5	16.2	22.4	34.2
4.1	3.37	5.66	8.78	16.71	23.10	35.17
4.2	3.43	5.81	9.06	17.22	23.80	36.13
4.3	3.50	5.97	9.33	17.73	24.50	37.10
4.4	3.57	6.12	9.61	18.24	25.20	38.07
4.5	3.63	6.28	9.89	18.76	25.90	39.03
4.6	3.70	6.43	10.17	19.27	26.60	40.00
4.7	3.77	6.59	10.44	19.78	27.30	40.97
4.8	3.83	6.74	10.72	20.29	28.00	41.93
4.85 (Kvs)	3.9	6.9	11.0	20.8	28.7	42.9

Flow Charts

DN 15

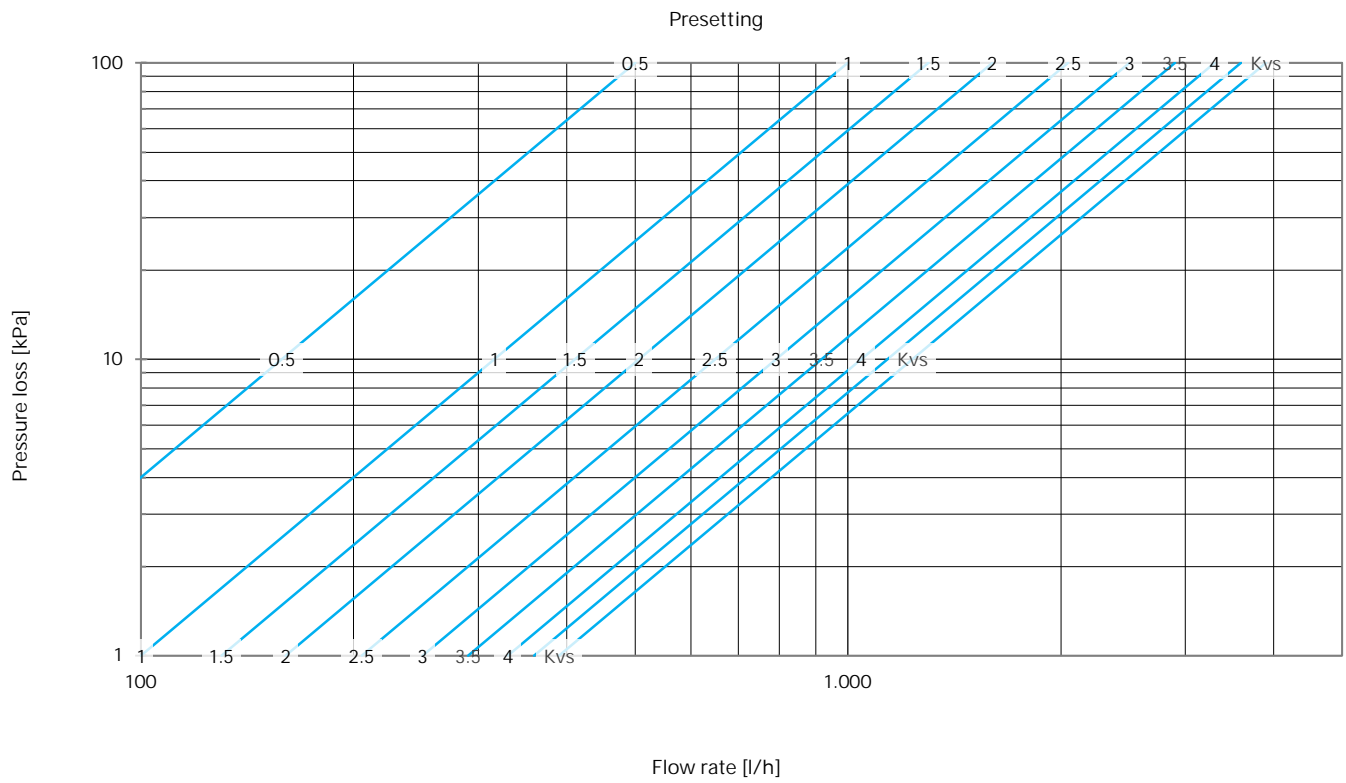

DN 20

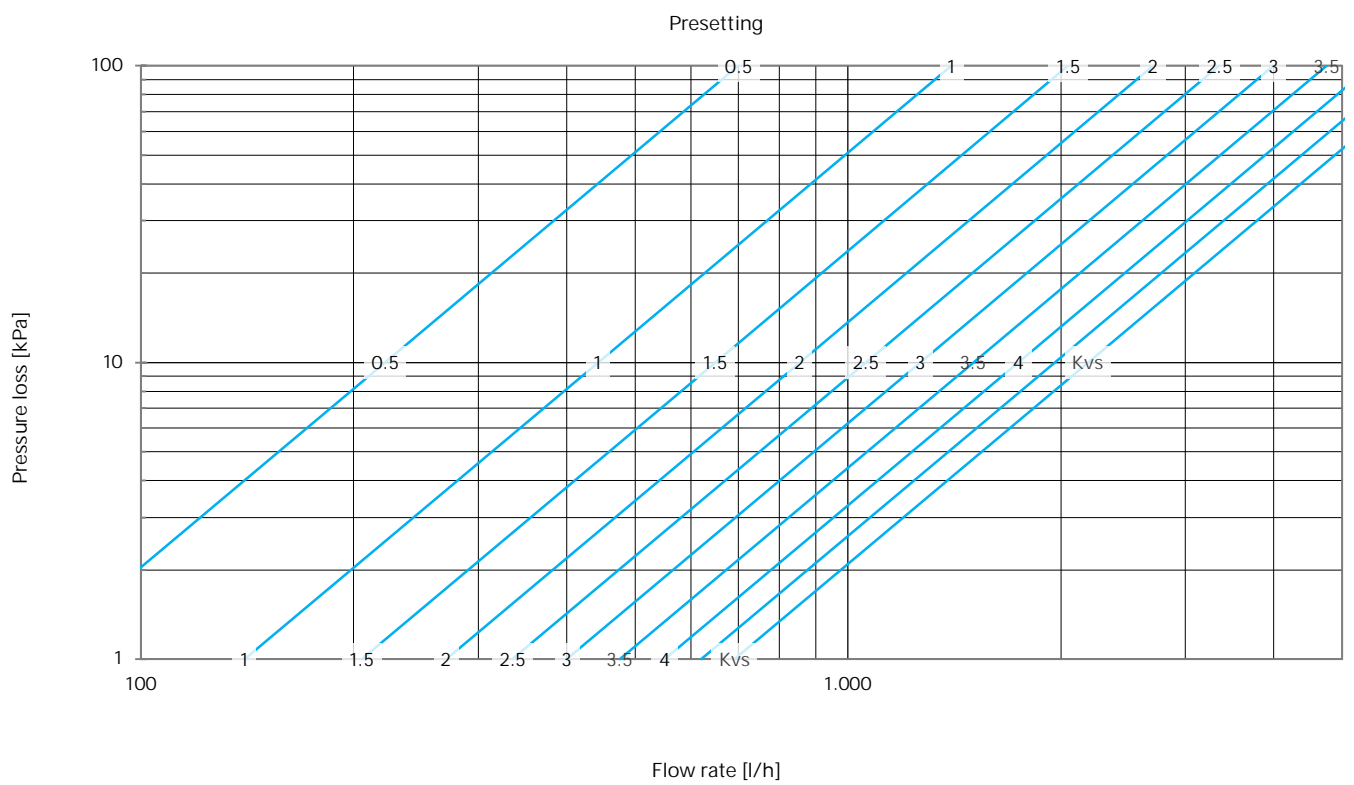

DN 25

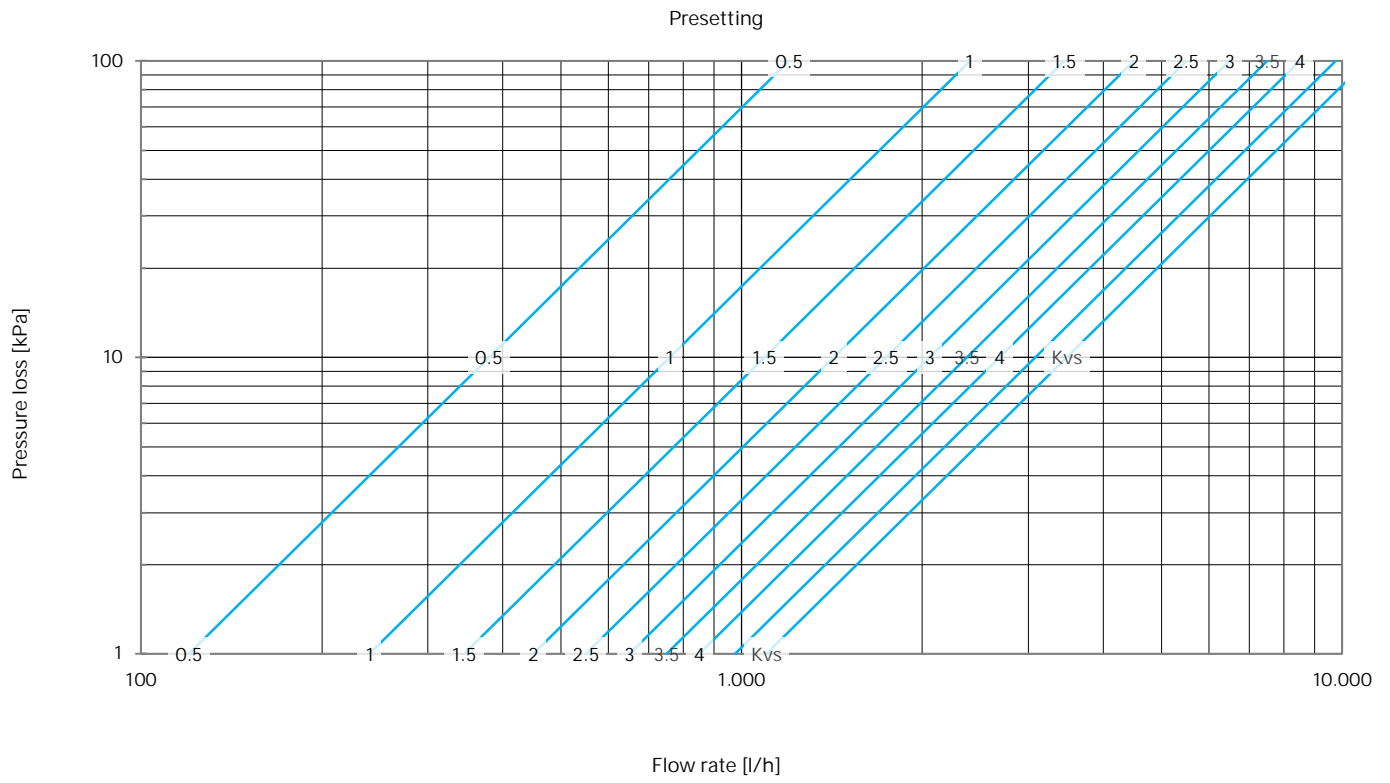

DN 32

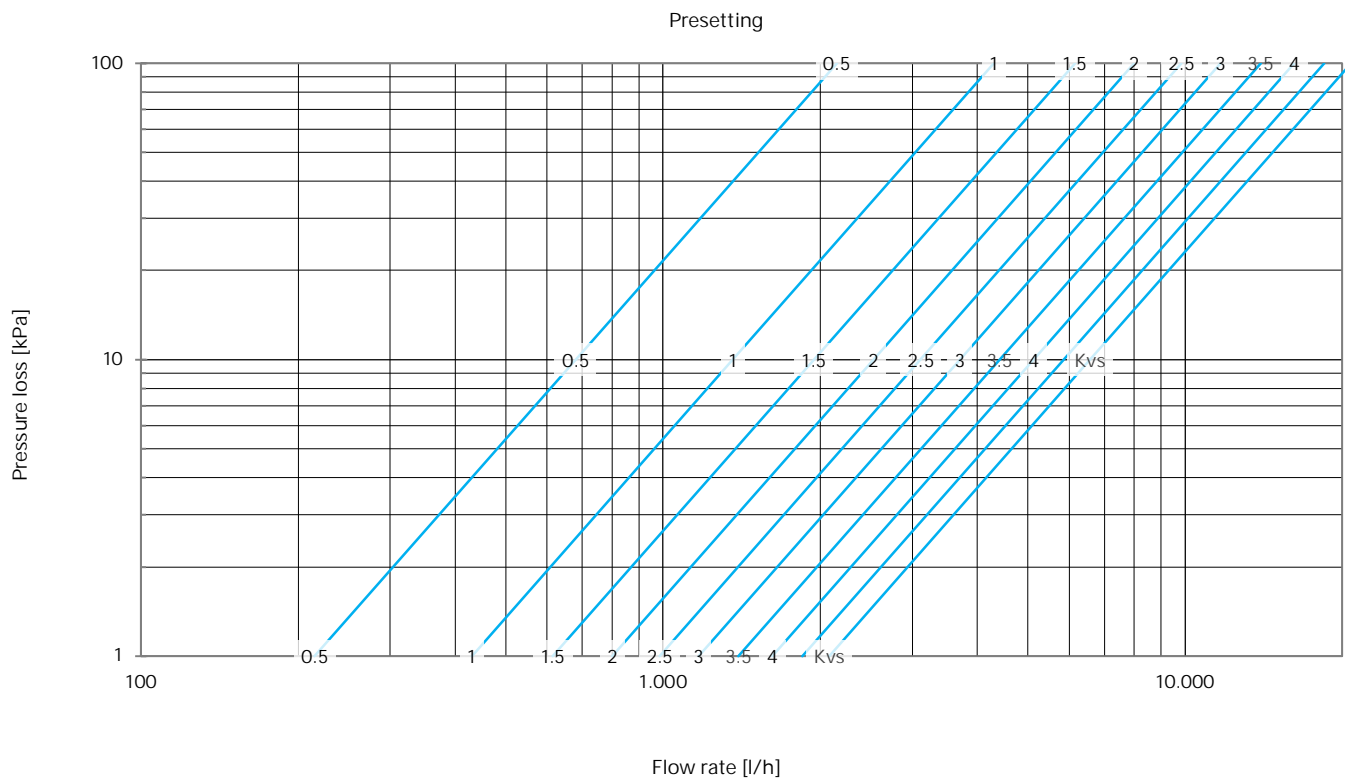

DN 40

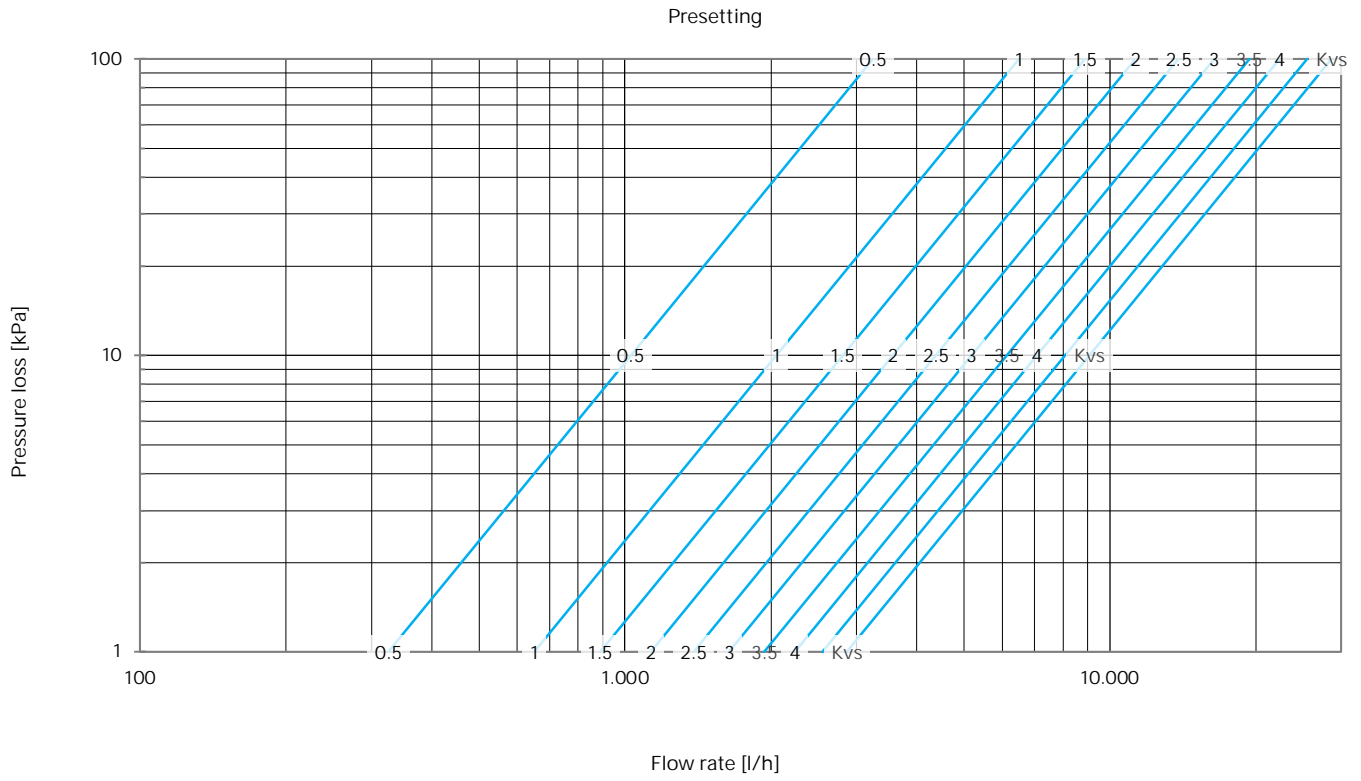

DN 50

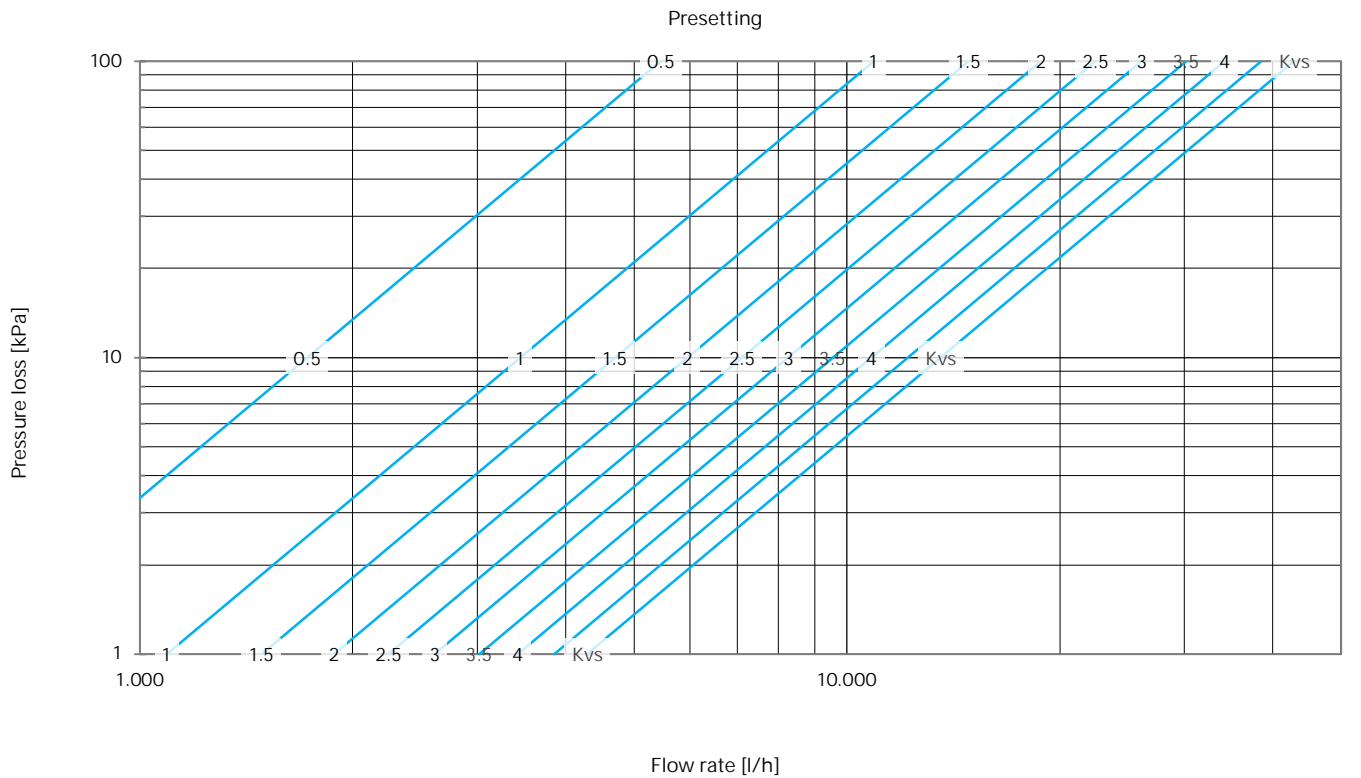

Kv Value Calculation

The flow coefficient Kv is the volume of water in m³ that flows through an opening within one hour with a pressure loss of 1 bar. For control and regulating valves, this opening is typically the gap between the valve seat and the valve plug. The required Kv value can be easily calculated with the Kv formula:

$$Kv = Q \times \sqrt{\frac{1 \text{ bar}}{\Delta P}} \times \frac{\rho}{1000 \frac{\text{kg}}{\text{m}^3}}$$

- Q is the volume flow in m³/h
- ΔP is the pressure loss in bar
- ρ is the density in kg/m³ — water with a temperature of 4 °C has a density of 1.000 kg/m³. At 50 °C, water has a density of 988 kg/m³, at 70 °C of 978 kg/m³ and at 100 °C of 958 kg/m³

For use with Excel or other spreadsheets, the formula is:

$$=Q*\text{ROOT}((1/DP)*(p/1000))$$

C4	A	B	C	D	E
	Volume flow	Q	0.5 m ³ /h		
	Pressure loss	Dp	0.1 bar		
	Density	p	988 kg/m ³		
		Kv	1.57		

The objects in **semibold cyan** are to be replaced by values or cell references. Brackets have been replaced for better comprehension.

For an accurate Kv value calculation, you need the water temperature so that you can look up the density and enter the value into the formula. If a less precise calculation is sufficient, the formula can be simplified by shortening the second fraction by setting the density to 1,000 kg/m³ – which only applies to a water temperature of 4 °C gill, as mentioned above. The error in a Kv value calculated in this way is approx. 1% for water with a temperature of e.g. 70 °C (density 978 kg/m³).

To be calculated	Formula	Spreadsheet formula
Kv value (simplified)	$Kv = Q \times \sqrt{\frac{1 \text{ bar}}{\Delta P}}$	=Q*ROOT(1/DP)

Correction factors

Additives change the viscosity of water and thus its flow properties. Manufacturers of additives often provide calculation aids that consider the changed properties of the medium when using their products.

The flow data in this Product Data sheet are based on the properties of water without additives. A quick, but only approximate calculation of the changed flow values when using glycol mixtures is made with the correction factor f, which can be used to recalculate the Kv value or the required pressure loss:

To be calculated	Formula	Spreadsheet formula
Kv value (corrected)	$Kv_{(corr)} = Kv \times \frac{1}{\sqrt{f}}$	Kv*(1/(ROOT(f)))
Pressure loss (corrected)	$\Delta P_{(corr)} = \Delta P \times f$	DP*f

The correction factor can be read in the following two charts at the intersection of the values for media temperature and glycol content.

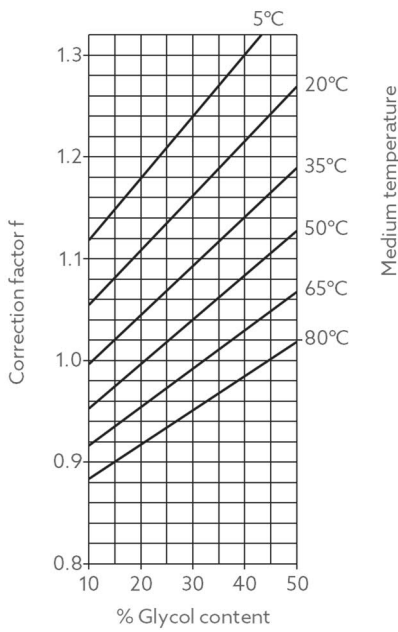

Correction factor f for ethylene glycol

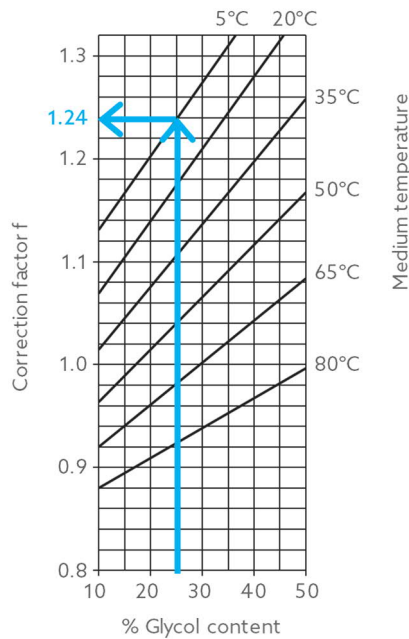

Correction factor f for propylene glycol

Example:

A glycol content of 25 % and a medium temperature of 5°C result in a factor of 1.24 with the following impacts:

- If the original Kv value was 10, it is now reduced to just short of 9
- If the original flow rate was 10 m³/h, it is now reduced to just short of 9 m³/h (at the same differential pressure)
- If the original differential pressure was 10 kPa, it must now be increased to 12.4 kPa to ensure the same flow rate

HydroSet



HydroSet is the digital data slider for Oventrop regulating valves. HydroSet can be used to determine the Kv value after entering the volume flow and differential pressure. When a valve is selected, the corresponding presetting is displayed.

HydroSet is suitable for all common operating systems and is available free of charge at the following link:

hydroset.owntrop.com



Subject to changes • All rights reserved • © 2022 Oventrop GmbH & Co. KG
EN-03123-10624-DB-V2328 – July 2023



Oventrop GmbH & Co. KG • Paul-Oventrop-Straße 1 • 59939 Olsberg • Germany
T +49 2962 820 • mail@oventrop.com • www.oventrop.com