



"Cocon QDP", PN25
Differential pressure regulator
Operating instructions



Contents

	Page
1. General information	5
1.1 Validity of the operating instruction.....	5
1.2 Extent of supply	5
1.3 Contact.....	5
1.4 Declaration of conformity.....	5
1.5 Symbols used.....	5
2. Safety-related information.....	6
2.1 Correct use.....	6
2.2 Warnings	6
2.3 Safety notes	6
2.3.1 Danger caused by inadequately qualified personnel	6
2.3.2 Risk of injury from pressurised components.....	6
2.3.3 Risk of burns due to an uncontrolled discharge of hot fluids	6
2.3.4 Risk of burns due to hot components and surfaces.....	6
2.3.5 Risk of injury in case of improper work.....	7
2.3.6 Damage to property due to an unsuitable installation location	7
2.3.7 Availability of the operating instructions	7
3. Technical description	7
3.1 Construction.....	7
3.2 Function	8
3.3 Technical data	8
4. Storage	9
5. Installation.....	9
5.1 Draining, filling and bleeding with the "Cocon QDP"	10
6. Commissioning.....	11
6.1 Setting of the volume flow.....	11
6.2 Pressurisation.....	12
6.3 Isolation of the regulator.....	12
6.4 User instruction	12
7. Maintenance	12
8. Advice for the user	12

9.	Removal and disposal.....	13
9.1	Removal of the regulator	13
9.2	Disposal.....	13
10.	Appendix	14
10.1	Handwheel settings characteristic lines DN 20.....	14
10.2	Handwheel settings characteristic lines DN 25.....	14

1. General information

The original operating instructions were drafted in German.

The operating instructions in other languages have been translated from German.

1.1 Validity of the operating instruction

These operating instructions are valid for the following sizes of the differential pressure regulator "Cocon QDP", PN25:

- DN 20
- DN 25

1.2 Extent of supply

Please check your delivery for any damages caused during transit and for completeness.

Items included in the delivery:

- Differential pressure regulator "Cocon QDP", PN25
- Capillary (1m)
- Fitting for the connection of the capillary to valves with "eco" measuring technique
- Adapter for the connection of the capillary to a G3/4 male thread (flat sealing)
- Operating instructions

1.3 Contact

Contact address

OVENTROP GmbH & Co. KG

Paul-Oventrop-Straße 1

59939 Olsberg

GERMANY

Technical services





Phone: +49 (0) 29 62 82-234

1.4 Declaration of conformity

Oventrop GmbH & Co. KG hereby declares that this product complies with the basic requirements and other relevant provisions of the EC Directives concerned.

The declaration of conformity can be obtained from the manufacturer..

1.5 Symbols used

	Highlights important information and further explanations.
	Action required
	List
1. 2.	Fixed order. Steps 1 to X.
	Result of action

2. Safety-related information

2.1 Correct use

Operating safety is only guaranteed if the product is used correctly.

The differential pressure regulator "Cocon QDP" is designed to be installed in central heating and cooling systems (like fan convectors (fan coil units), chilled ceiling modules, induction air systems, cooling and heating zones) with closed circuits.

The regulator with flow limitation and zone control is preset to a fixed nominal value for differential pressure control. It can also be used for the control of another variable (e.g. room temperature) by modifying the flow rate with the help of actuators, thermostats or temperature controllers.

Any other use of the product, especially in potable water installations, will be considered incorrect use. The regulator is not suitable for steam, oily and aggressive fluids.

Claims of any kind against the manufacturer and/or its authorised representatives due to damage caused by incorrect use will not be accepted.



Observance of the operating instructions is part of compliance with correct use.



2.2 Warnings



Each warning contains the following elements:

Warning symbol SIGNAL WORD	
	<p>Type and source of danger Possible consequences if the danger occurs or the warning is ignored.</p> <ul style="list-style-type: none"> ► Ways to avoid the danger.

The signal words identify the severity of the danger arising from a situation.

 DANGER	
	<p>Indicates an imminent danger with high risk. The situation will lead to death or serious injury if not avoided.</p>

 WARNING	
	<p>Indicates a possible danger with moderate risk. The situation may lead to death or serious injury if not avoided.</p>

 CAUTION	
	<p>Indicates a possible danger with lower risk. The situation will lead to minor and reversible injury if not avoided.</p>

NOTICE	
	<p>Indicates a situation that may lead to damage to property if not avoided.</p>

2.3 Safety notes

We have developed this product in accordance with current safety requirements.

Please observe the following notes concerning safe use.

2.3.1 Danger caused by inadequately qualified personnel

Any work on this product must only be carried out by qualified tradesmen.

As a result of their professional training and experience as well as their knowledge of the relevant legal regulations, qualified tradesmen are able to carry out any work on the described product professionally.

User

The user must be informed how to operate the product by a qualified tradesman.

2.3.2 Risk of injury from pressurised components

- Only carry out work when the system is depressurised.
- Observe the permissible operating pressures during operation.

2.3.3 Risk of burns due to an uncontrolled discharge of hot fluids

- Only carry out work when the system is depressurised.
- Allow the product to cool down before working on it.
- Check that the product is not leaking after work is complete.
- Wear safety goggles.

2.3.4 Risk of burns due to hot components and surfaces

- Allow the product to cool down before working on it.
- Wear suitable protective clothing to avoid unprotected contact with hot system components and fittings.

2.3.5 Risk of injury in case of improper work

Stored energies, angular components, protrusions and edges both inside and outside the product may cause injuries.

- ▶ Before starting work, make sure that there is enough space.
- ▶ Handle open and hard-edged components with care.
- ▶ Make sure that the work place is tidy and clean to avoid accidents.

2.3.6 Damage to property due to an unsuitable installation location

- ▶ Do not install the product in locations prone to frost.
- ▶ Do not install the product in locations with corrosion-enhancing ambient air.
- ▶ Observe the advice regarding corrosion protection.

2.3.7 Availability of the operating instructions

Any person working on the product has to read and apply these operating instructions and all other valid documents.

The operating instructions must be available at the installation location of the product.

- ▶ Hand these operating instructions and all other relevant documents (e.g. accessory manuals) over to the user.

3. Technical description

3.1 Construction

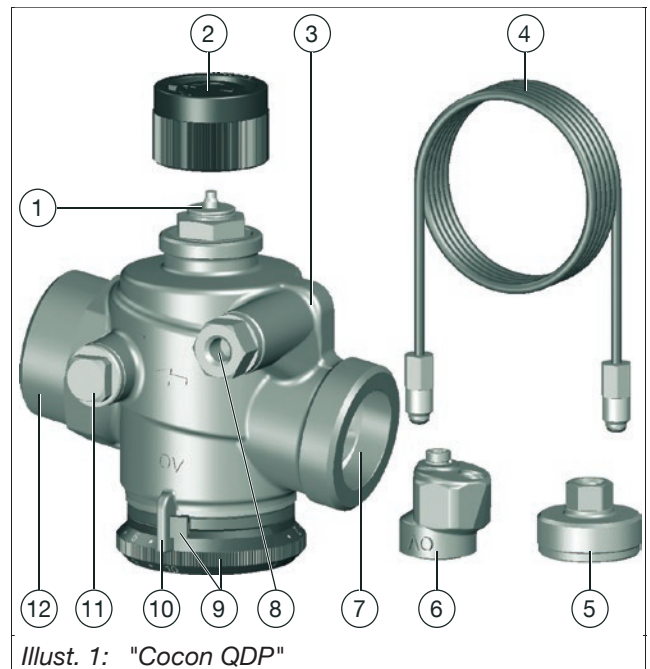

(1)	Actuator location
(2)	Protection cap
(3)	Body
(4)	Capillary (1m)
(5)	Adapter for the connection of the capillary to a G $\frac{3}{4}$ male thread (flat sealing)
(6)	Fitting for the connection of the capillary to valves with "eco" measuring technique
(7)	Fluid inlet
(8)	Connection with adapter for the connection of the capillary
(9)	Handwheel with locking ring
(10)	Nominal value marking
(11)	Connection closed with a blind plug
(12)	Fluid outlet

3.2 Function

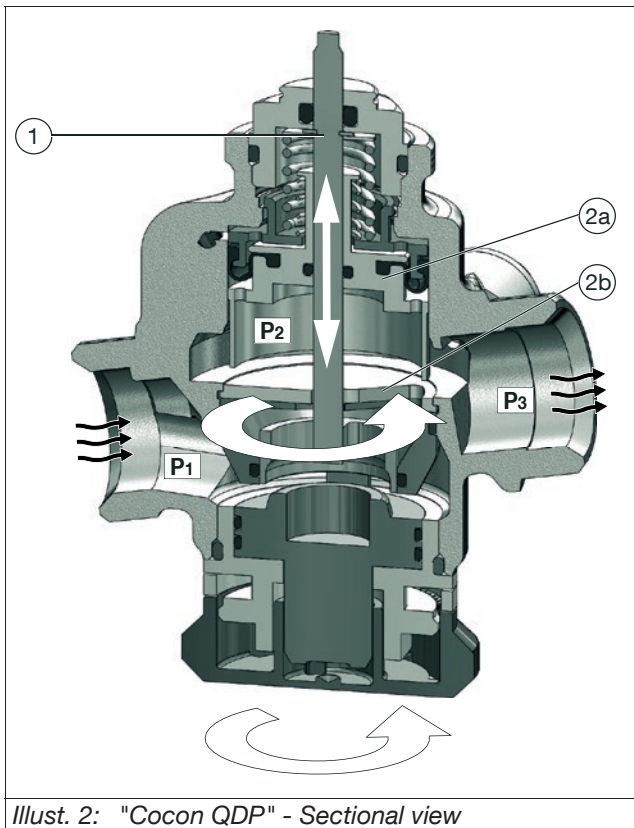

Illust. 2: "Cocon QDP" - Sectional view

(1)	Regulating unit
(2)	Flow regulating unit
(2a)	Diaphragm unit
(2b)	Nominal value unit (adjustable with the help of the handwheel)

The differential pressure regulators "Cocon QDP" are proportional regulators working without auxiliary energy and are designed to maintain a constant differential pressure within a necessary proportional band. The integrated diaphragm unit (2a) maintains the system pressure (Δp) at a constant fixed preset value. This way, pressure variations which may, for instance, occur if section of the system are activated or inactivated are avoided.

For zone control, the differential pressure regulator "Cocon QDP" can be equipped with an actuator actuating the regulating unit (1).

The regulating unit (1) has an almost linear characteristic line.

Room temperature control can, for instance, be carried out with the help of actuators and room thermostats. The maximum volume flow (full load) is limited by the nominal value unit (2b) with the help of the presetting at the handwheel. Operation during low demand periods is controlled via the piston stroke of the actuator.

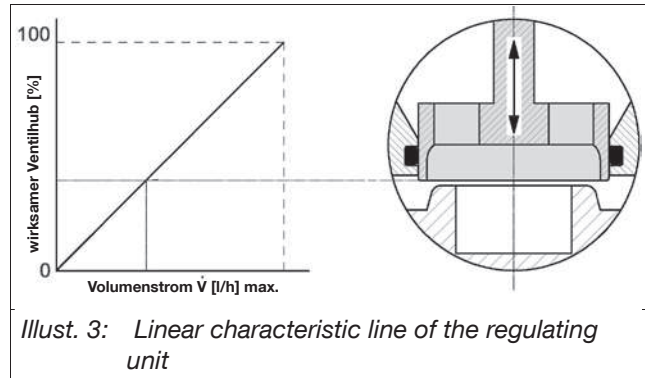

Illust. 3: Linear characteristic line of the regulating unit

3.3 Technical data

Technical data	
Max. operating pressure (p_o)	25 bar (2500 kPa)
Operating temperature (t_o) (min.-max.)	-10 to 120 °C
Fluid	- Water/mixtures of water and glycol (max. 50%) according to VDI 2035 / ÖNORM 5195 - pH value: 6.5-10 Not suitable for steam, oily and aggressive fluids
Markings on the body	DN = Size PN = Nominal pressure OV = Oventrop
Max. closing pressure	4 bar (400 kPa) in the direction of flow
Closing dimension	11.8 mm
Materials	Dezincification resistant brass (body) EPDM (seals) Stainless steel (stem)
Data for actuator connection	
Connection thread	M30 x 1.5
Closing pressure (actuator) min. - max.	90 – 150 N
Upper lift position	15.8 or higher
Lower lift position	11.3 mm or lower
Setting of the volume flow	
Min. differential pressure Δp_0	0.2 bar
Max. differential pressure Δp_0	3 bar
Valve lift	4 mm

4. Storage

Store the product under the following conditions:

- At a temperature range between -20 °C and +55 °C.
- At a max. relative air humidity of 95%.
- Dry and free from dust.
- Protected from UV rays and direct sunlight.
- Do not store together with solvents, chemicals, acids, fuels or similar substances.

5. Installation

The differential pressure regulators "Cocon QDP" are designed for installation in the return pipe of heating and cooling systems.

Installation is possible in any position.

The pipework must be free from foreign bodies (e.g. shavings, sealant, dirt). Impurities as well as grease and oil residues must be flushed out of the pipework.



Please note that some actuators must not be installed in a vertical downward position. Please refer to the actuator manual for details on the installation position.



WARNING

Risk of injury from pressurised components

Fluids escaping under pressure may lead to injuries.

- ▶ Only carry out work when the system is depressurised.
- ▶ When retrofitting an existing system: drain the system or close the supply pipes of the section of the system and depressurise it.
- ▶ Wear safety goggles.



CAUTION

Risk of scalding due to hot fluids

If the system has been in operation, there is a risk of scalding due to the unintentional discharge of hot water or water steam.

- ▶ Allow the system to cool down.
- ▶ Wear safety goggles.



CAUTION

Risk of burns due to hot components

Any unprotected contact with hot components may lead to burns.

- ▶ Wear safety gloves.



During installation, ensure that the direction of flow conforms to the direction of the arrow on the regulator body.



- The installation of an isolating valve in front of and behind the regulator or section of the system is recommended for maintenance work.
- The regulator must be easily accessible.

NOTICE

Risk of damage to property due to lubricants

Seals may be destroyed by greasing agents or oil.

- ▶ Do not use any greasing agents or oil for the installation.
- ▶ Flush any dirt particles or oil residues out of the pipework before installing the product.
- ▶ Consider the latest technical status (e.g. VDI 2035) when choosing the operating fluid.
- ▶ Install a strainer in the supply pipe to avoid contaminated operating fluids (VDI 2035).

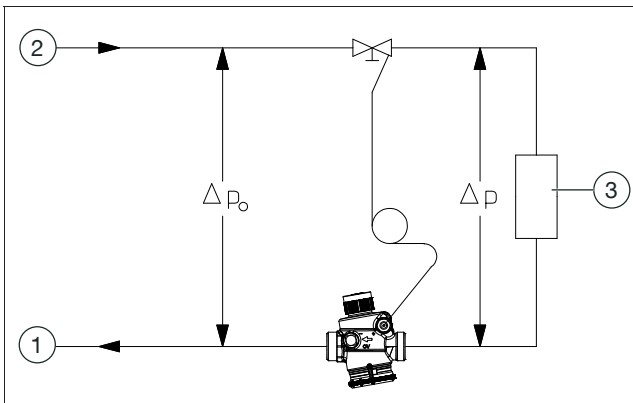

Illust. 4: Installation example

(1)	Return
(2)	Supply
(3)	Installation

5.1 Draining, filling and bleeding with the "Cocon QDP"

Sections of the system can be drained, filled, flushed and bled with the "Cocon QDP" in installed condition. A fill and drain ball valve (accessory, item no. 1060191) which is fitted to connection (G ¼) (see position (11) in Illust. 1) on the outlet side of the regulator is used for this purpose.

i Drain the differential pressure regulator "Cocon QDP" respectively the concerned section of the system before fitting the fill and drain ball valve.

1. Isolate the regulator, for instance with the help of the protection cap (see Illust. 5).

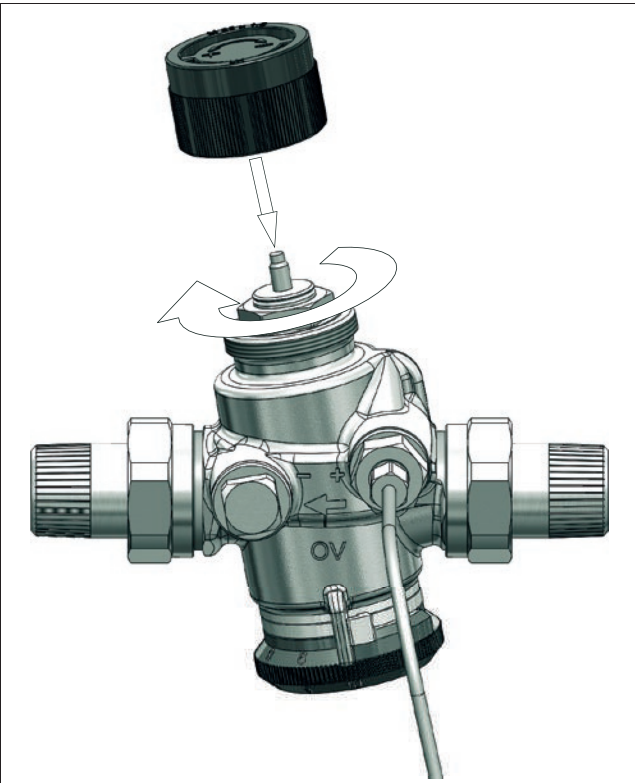

Illust. 5: Isolation

2. Open the fill and drain ball valve (stem spanner size 5 mm) to start draining, filling or flushing.

6. Commissioning

! WARNING

Risk of injury from pressurised components
 Fluids escaping under pressure may lead to injuries.
 If the heating system is in operation, there is a risk of scalding due to the unintentional discharge of hot water or water steam.

- ▶ During filling, check all couplings for tightness and re-tighten them if required.
- ▶ Wear safety goggles.

NOTICE

Risk of damage due to pressure surges
 Sudden filling of the installation with water may lead to damages.

- ▶ Always open and close the isolating valves slowly.

6.1 Setting of the volume flow

Set the desired volume flow with the help of the handwheel (see Illust. 6).

1. Remove the locking ring (2).
2. Push the handwheel (3) and turn it until the nominal value marking (1) is in line with the desired flow rate (the handwheel will snap back into the cogs).
3. Refit the locking ring (2).

i (See Illust. 7.)
 As an option, the locking ring (5) can be lead locked at the nominal value marking (6) with the help of the lead sealing set (4) (accessory, item no. 1089091).

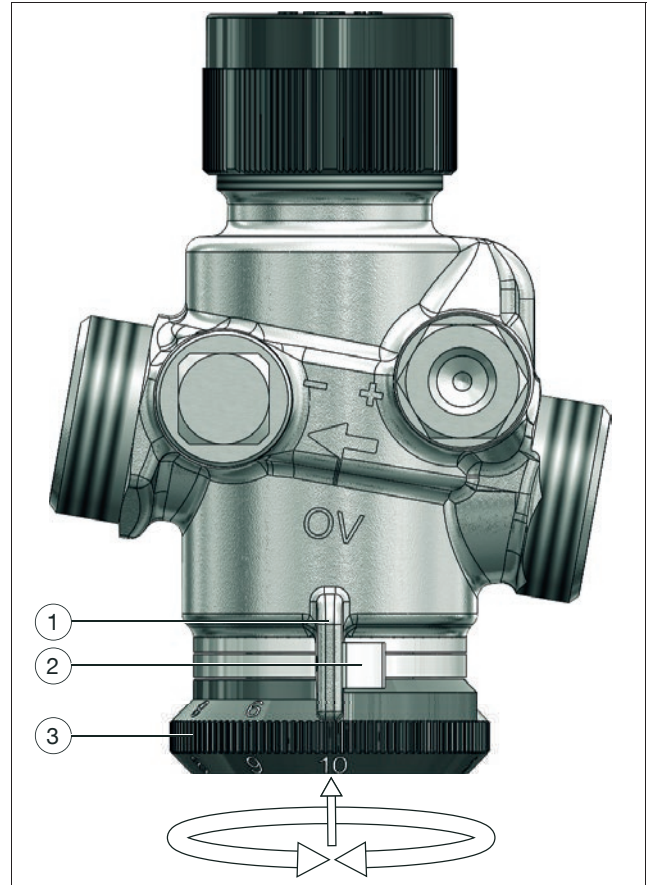

Illust. 6: Setting of the volume flow

(1)	Nominal value marking
(2)	Locking ring
(3)	Handwheel

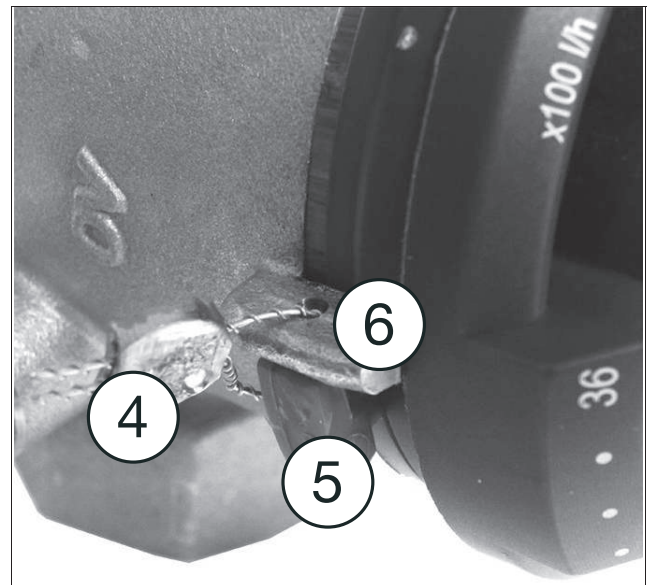

Illust. 7: Securing of the presetting

(4)	Lead sealing set
(5)	Locking ring
(6)	Nominal value marking

6.2 Pressurisation

- ▶ Once installation is complete, fill the section of the system with the operating fluid. The operating fluid has to comply with the latest technical status according to VDI 2035.



After having pressurised the system, check all installation points **for leaks** .



Take the correction factors of the manufacturers of the antifreeze liquid into consideration when setting the flow rate.

6.3 Isolation of the regulator

Screw the supplied protection cap onto the M 30 x 1.5 connection thread of the regulator (see Illust. 5).



Only use the protection cap for a temporary isolation. Use the manual head (accessory, item no. 1012565) or the combined cap (accessory, item no. 1627965) for a permanent isolation of the regulator.

The protection cap must not be used for the isolation of the valve against system pressure (for instance while a section of the system is dismantled).

6.4 User instruction

- ▶ The user must be informed how to operate the product by a qualified tradesman.
- ▷ Commissioning is complete.

7. Maintenance

The differential pressure regulator is maintenance-free.

8. Advice for the user

- ▶ Regularly check the tightness and function of the product and its connection points as part of system maintenance.
- ▶ Replace the product if it malfunctions or leaks. In this case, please contact your qualified tradesman.

9. Removal and disposal

 CAUTION	
	<p>Risk of injury from pressurised fluids Fluids escaping under pressure may lead to injuries.</p> <ul style="list-style-type: none"> ▶ Only carry out work when the system is depressurised. ▶ Close the isolating valves in front of and behind the "Cocon QDP". ▶ Depressurise and drain off the section of the system. ▶ Wear safety goggles. ▶ Any work on the system must only be carried out by qualified tradesmen.

 CAUTION	
	<p>Risk of scalding due to hot fluids If the system has been in operation, there is a risk of scalding due to the unintentional discharge of hot water or water steam.</p> <ul style="list-style-type: none"> ▶ Allow the system to cool down. ▶ Wear safety goggles.

 CAUTION	
	<p>Risk of burns due to hot components Any unprotected contact with hot components may lead to burns.</p> <ul style="list-style-type: none"> ▶ Allow the system to cool down. ▶ Wear safety gloves.

9.1 Removal of the regulator

- ▶ Remove the regulator from the installation.

9.2 Disposal

NOTICE	
	<p>Risk of environmental pollution Incorrect disposal (for instance with standard waste) may lead to environmental damage.</p> <ul style="list-style-type: none"> ▶ Dispose of packaging material in an environmentally friendly manner. ▶ Dispose of the components appropriately.

If no return or disposal agreement has been made, dispose of the product yourself.

- ▶ If possible, recycle the components.
- ▶ Dispose of components which cannot be recycled according to local regulations. Disposal with the standard waste is not permitted.

10. Appendix

10.1 Handwheel settings characteristic lines DN 20

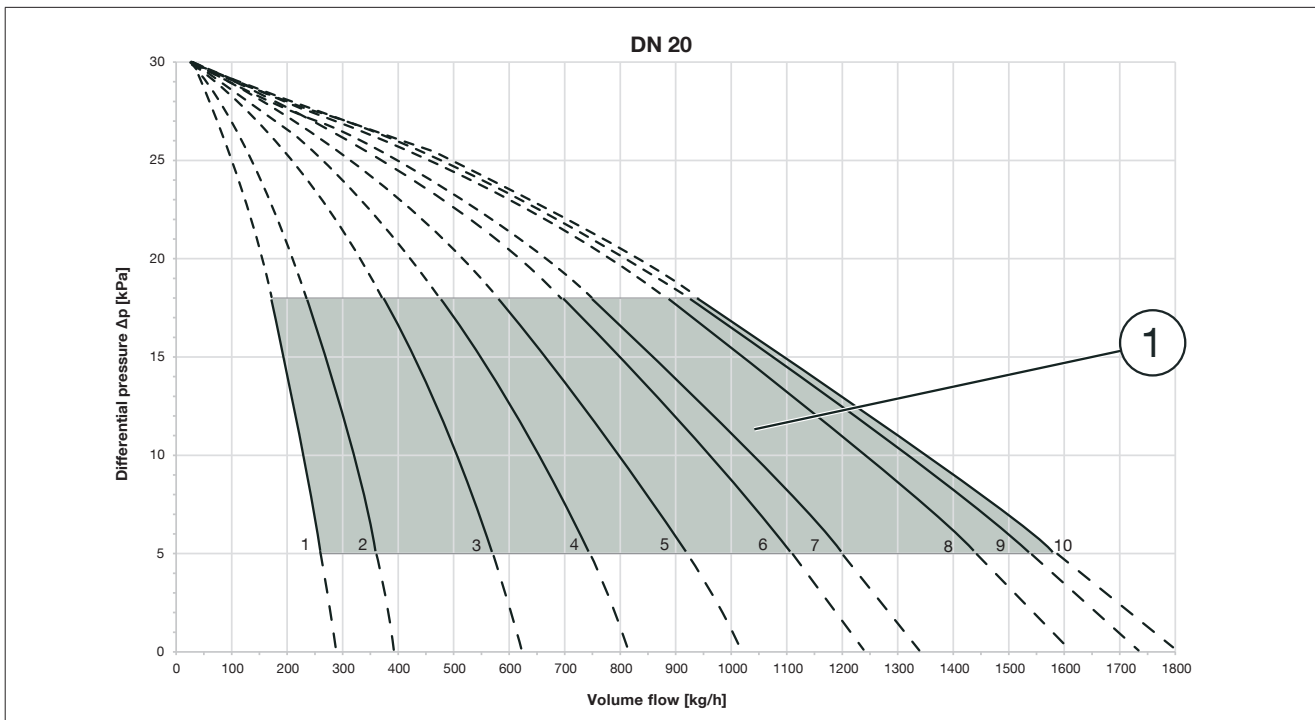

Illust. 8: Handwheel settings characteristic lines DN 20

(1) Recommended application range 5 to 18 kPa (highlighted in grey)

10.2 Handwheel settings characteristic lines DN 25

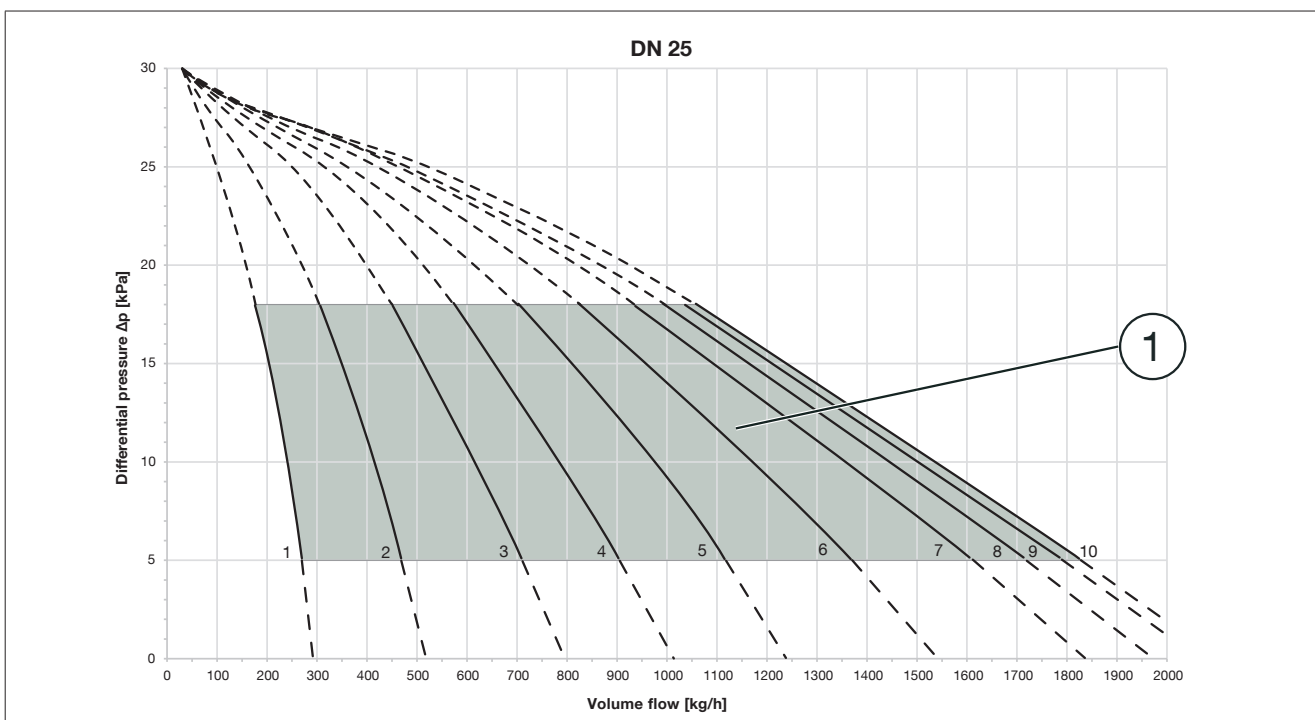

Illust. 9: Handwheel settings characteristic lines DN25

(1) Recommended application range 5 to 18 kPa (highlighted in grey)

